

Individual wiring block manifold Body porting **MN4GA1/2 Series**

- Applicable cylinder bore size: 20 to 80 mm



CAD DATA AVAILABLE.

Manifold common specifications

Descriptions	
Manifold type	Block manifold
Installation method	DIN rail mount type
Air supply/exhaust air method	Common supply/exhaust (check valve incorporated)
Pilot exhaust method	Main/pilot valves' common exhaust (pilot exhaust check valve incorporated)
Piping direction	Valve top direction
Working fluid	Compressed air
Valve and solenoid type	Pilot operated soft spool valve
Min. working pressure MPa	0.2 (2,3-position)
Max. working pressure MPa	0.7
Withstanding pressure MPa	1.05
Ambient temperature °C	-5 to 55
Fluid temperature °C	5 to 55
Manual override	Non-locking/locking type
Lubrication Note 1	Not required
Protection structure Note 2	Dust proof
Vibration/impact m/s ²	50 or less/300 or less
Working environment	Not to be subject to corrosive gas

- Note 1. For lubrication, please use turbine oil Class 1 ISOVG32.
Too much lubrication, intermittent lubrication may cause unstable operation.
- Note 2. Protection structure is dust proof, but not drip proof.
Not to be subject to water drip, oil etc.
- <Reference> Pressure unit is MPa. Conversion ratio is 1MPa=10.1972kgf/cm².

Electrical specifications

Descriptions		
Rated voltage V	DC	12, 24
	AC	100
Fluctuation range		±10%
Holding current	DC24	0.023(0.025)
	DC12	0.046(0.050)
Note 3. A	AC100	0.010(0.012)
	DC24	0.55(0.6)
Power consumption Note 3. W	DC12	0.55(0.6)
	AC100	1.0(1.2)
Apparent power VA		1.0(1.2)
Heat proof class		B
Temperature rise °C		50
Surge suppressor		Option
Indicator		(Option) indicator light

Note 3. For indicator light, refer to the value in ().

Please refer to Page 244 about JIS symbol.

Individual specifications

Descriptions		MN3GA1/MN4GA1	MN3GA2/MN4GA2
Max. station number		24 station	20 station
Port size	Port A/B	Push in joint 4, 6 mm dia. M5	Push in joint 4, 6, 8 mm dia. Rc1/8
	Port P/R	Push in joint 6, 8, 6.4 mm dia.	Push in joint 8, 10 mm dia.

Refer to " 3 About installation attitude" on Page 82 about DIN rail mount.
Please refer to Page 250 about mass.

Descriptions			MN3GA1/MN4GA1		MN3GA2/MN4GA2		
			P → A/B	A/B → R	P → A/B	A/B → R	
Effective sectional area mm ²	Port size	Port A/B	Push in joint 6 mm dia.		Push in joint 8 mm dia.		
	2-position	All ports closed	5.0	4.0(5.5)	11	9.0(12)	
			ABR connection	5.0	4.0(5.5)	10	9.0(12)
				PAB connection	6.0	5.5	13

- Effective sectional area of 2-position and ABR connection is the value when check valve incorporated.
- When no check valve installed, refer to the value in ().

Descriptions			MN3GA1/MN4GA1		MN3GA2/MN4GA2	
			When ON	When OFF	When ON	When OFF
Response time ms	2-position	Single	12	12	19	19
		Double	9	-	18	-
	3-position	ABR connection	8	15	17	30

The value of light, surge suppressor is shown. Response time is the value at supply pressure 0.5MPa, 20°C, not lubricated. The value varies depending on pressure and oil quality.

MN4GA1/2 Series

Individual wiring type block manifold: Body porting

How to order

Manifold model No.

MN4GA1 (1) 0 • C6 • E2 H • 10 • 3

Discrete valve block with solenoid valve

N4GA1 (1) 0 • C6 • E2 H — 3

Discrete solenoid valve

4GA1 (1) 9 • C6 • E2 H — 3

Ⓐ Solenoid position

Model

Ⓑ Port size
Note 1

Ⓒ Electric connection

Ⓓ Options

Ⓔ Station #

Ⓕ Voltage

- Complete "manifold specification sheet" (Page 306 to 308).

Symbol	Descriptions	Model								
		Manifold				Discrete valve block with solenoid valve				
		3 port valve	5 port valve	Discrete solenoid valve		Discrete solenoid valve		Discrete solenoid valve		
		MN3GA1	MN3GA2	MN4GA1	MN4GA2	N3GA1/3GA1	N3GA2/3GA2	N4GA1/4GA1	N4GA2/4GA2	
A Solenoid position										
1	2-position single			●	●			●	●	
2	2-position double			●	●			●	●	
3	3-position all ports closed			●	●			●	●	
4	3-position ABR connection			●	●			●	●	
5	3-position PAB connection			●	●			●	●	
1	2-position single solenoid, normally closed	●	●			●	●			
11	2-position single solenoid, normally open	●	●			●	●			
8	Mix manifold	●	●	●	●					
B Port size (Port A/B)										
C4	4 mm push in joint	●	●	●	●	●	●	●	●	
C6	6 mm push in joint	●	●	●	●	●	●	●	●	
C8	8 mm push in joint		●		●		●		●	
CX	Mix push in joint	●	●	●	●					
M5	M5 female thread	●		●		●		●		
06	Rc1/8		●		●		●		●	
C Electric connection										
Blank	Grommet lead wire (300mm)									●
B	DIN terminal box (Pg7) surge suppressor/indicator light		●		●		●		●	
E-connector (up/lateral common)										
E0	Lead wire (300mm)	●	●	●	●	●	●	●	●	●
E00	Lead wire (500mm)	●	●	●	●	●	●	●	●	●
E01	Lead wire (1000mm)	●	●	●	●	●	●	●	●	●
E02	Lead wire (2000mm)	●	●	●	●	●	●	●	●	●
E03	Lead wire (3000mm)	●	●	●	●	●	●	●	●	●
E2	Lead wire (300mm) surge suppressor/light	●	●	●	●	●	●	●	●	●
E20	Lead wire (500mm) surge suppressor/light	●	●	●	●	●	●	●	●	●
E21	Lead wire (1000mm) surge suppressor/light	●	●	●	●	●	●	●	●	●
E22	Lead wire (2000mm) surge suppressor/light	●	●	●	●	●	●	●	●	●
E23	Lead wire (3000mm) surge suppressor/light	●	●	●	●	●	●	●	●	●
E0N	No lead wire (no socket)	●	●	●	●	●	●	●	●	●
E2N	No lead wire (no socket) surge suppressor/light	●	●	●	●	●	●	●	●	●
E3	No lead wire (socket/terminal attached) surge suppressor/light	●	●	●	●	●	●	●	●	●
E1	No lead wire (socket/terminal attached)	●	●	●	●	●	●	●	●	●
EJ-connector (socket with cover, radial/axial common)										
E01J	Lead wire (1000mm)	●	●	●	●	●	●	●	●	●
E02J	Lead wire (2000mm)	●	●	●	●	●	●	●	●	●
E03J	Lead wire (3000mm)	●	●	●	●	●	●	●	●	●
E21J	Lead wire (1000mm) surge suppressor/light	●	●	●	●	●	●	●	●	●
E22J	Lead wire (2000mm) surge suppressor/light	●	●	●	●	●	●	●	●	●
E23J	Lead wire (3000mm) indicator light	●	●	●	●	●	●	●	●	●
D Option										
Blank	No option	●	●	●	●	●	●	●	●	●
H	Check valve (standard)	●	●	●	●	●	●	●	●	●
K	External pilot	●	●	●	●	●	●	●	●	●
A	Ozone/coolant proof	●	●	●	●	●	●	●	●	●
F	Filter incorporated in Port A/B (Port P: Provided as STD)	●	●	●	●	●	●	●	●	●
E Station #										
1	1 station									
to	to	●	●	●	●					
24	24 station (max. station number of MN3GA2/MN4GA2 is 20.)									
F Voltage										
1	AC100V (rectified bridge incorporated)	●	●	●	●	●	●	●	●	●
3	DC24V	●	●	●	●	●	●	●	●	●
4	DC12V	●	●	●	●	●	●	●	●	●

is not available.

⚠ Precautions for selection guide

Note 1. Designate port size of Port P/R in supply and exhaust block model No. on the manifold specification sheet.

Note 2. AC100V is not available for grommet lead wire specifications.

Note 3. For 3-position all ports closed and PAB connection, check valve specifications (H) are not available.

Note 4. Consult with CKD about vacuuming of external pilot (K).

4SA/B0

4SA/B1

4GA/B

MN4GA/B

4GA/B (master)

MN3S0/ MN4S0

4TB

4L2-4/ LMFO

4KA/B

4F

PV5/ CMF

3MA/B0

3PA/B

P/M/B

NP/NAP/ NVP

4F**0E

HMV/ HSV

Uniwire system

SKH

PCD/ FS/FD

3, 5 port pilot operated valve

Individual wiring block manifold

MN4GA1/2 Series

Individual wiring type block manifold: Body porting

Explanation of manifold components and parts list

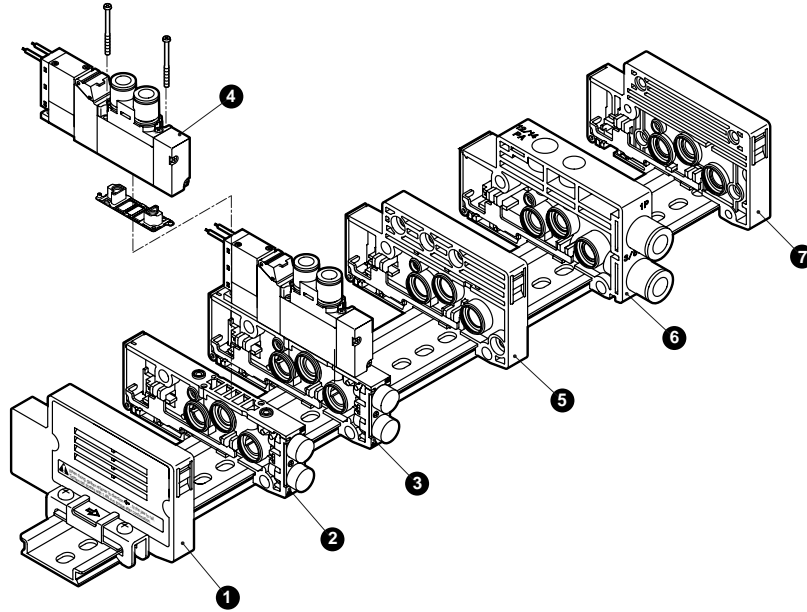

Main parts list (please refer to Page 249 to 303 about details.)

No.	Components name	Model No. (e.g.)	No.	Components name	Model No. (e.g.)
1	End block L	N4G1-EL	5	Partition block	N4G1-S
2	Discrete valve block	N4GA1-V1	6	Supply and exhaust block	N4G1-Q-8
3	Discrete valve block with solenoid valve	N4GA110-C6-H-3	7	End block R	N4G1-ER
4	Electromagnetic valve body	4GA119-C6-H-3			

A type individual wiring mass

4GA1

Block type	Model No.	Mass	Block type	Model No.	Mass
Valve block with solenoid valve	N3GA110-C6NC	73	Supply and exhaust block	N4G1-Q-8	63
	N3GA1110-C6NO	73		N4G1-QK-8	68
	N4GA110-C6	73	End block	N4G1-E *	57
	N4GA120-C6	88		N4G1-EX *	57
	N4GA1 $\frac{3}{4}$ 0-C6	90	Partition block	N4G1-S	45
Valve block with masking plate	N4GA1-MP	34			

4GA2

Block type	Model No.	Mass	Block type	Model No.	Mass
Valve block with solenoid valve	N3GA210-C8NC	141	Supply and exhaust block	N4G2-Q-10	99
	N3GA2110-C8NO	141		N4G2-QK-10	104
	N4GA210-C8	141	End block	N4G2-E *	83
	N4GA220-C8	156		N4G2-EX *	84
	N4GA2 $\frac{3}{4}$ 0-C8	168	Partition block	N4G2-S	60
Valve block with masking plate	N4GA2-MP	66			

Repair parts and related part list

No.	Parts name	Model No.	No.	Parts name	Model No.		
-	Coil assembly	4G-[Electric connection] *-COIL -[Voltage]	-	E-connector	4G - SOCKET ASSY - [Electric connection] - [Voltage]		
		Blank: Standard A: Ozone proof	-	Socket assembly			
		Page 249 Select according to (C) Electric connection.	-	EJ-connector	4G - SOCKET ASSY - [Electric connection]		
			-	Socket assembly			
			-	DIN terminal box assembly	4G - TERMINAL BOX - [Voltage]		
-	Cartridge type quick connector and related parts	4G1	-	Silencer	For 6 dia: SLW-H6		
					4 dia. straight type	4G1-JOINT-C4	For 8 dia: SLW-H8
					6 dia. straight type	4G1-JOINT-C6	For 10 dia: SLW-H10
		Plug cartridge			4G1-JOINT-CPG		
		4G2			4 dia. straight type	4G2-JOINT-C4	
					6 dia. straight type	4G2-JOINT-C6	
8 dia. straight type	4G2-JOINT-C8						
		Plug cartridge	4G2-JOINT-CPG				

Dimensions

MN4GA1  (File name: Page 314 or Ending 19)

- Grommet lead wire (blank)

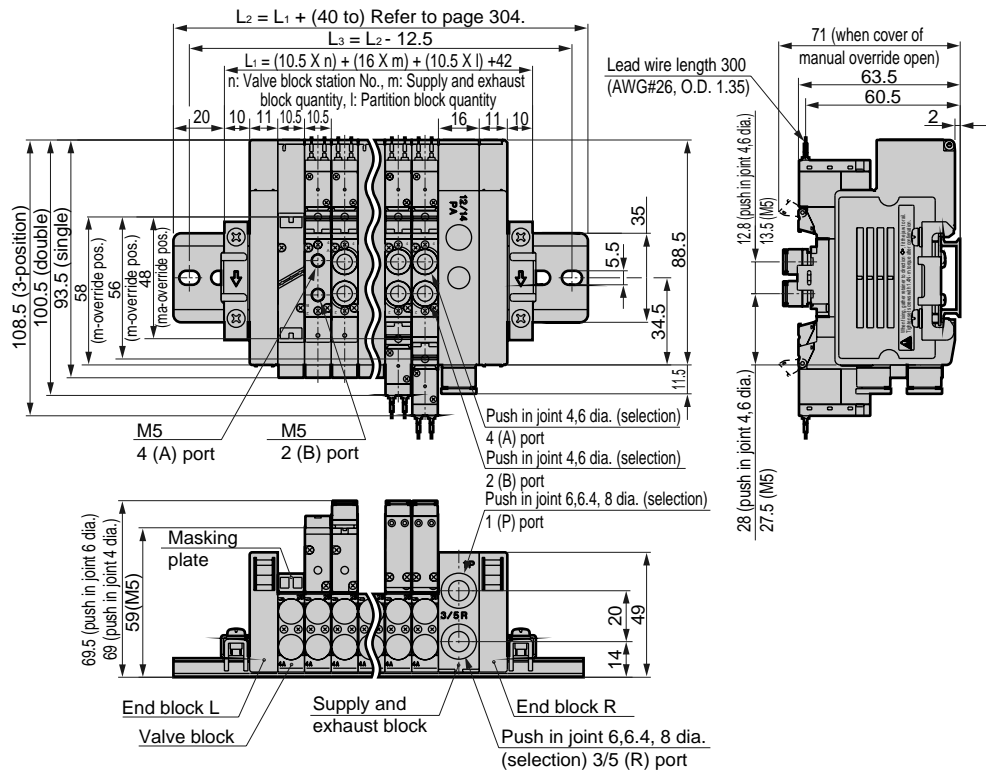
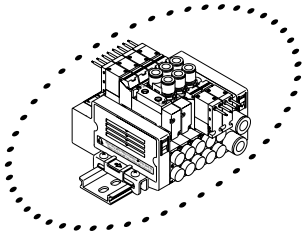

- E-connector type (E)

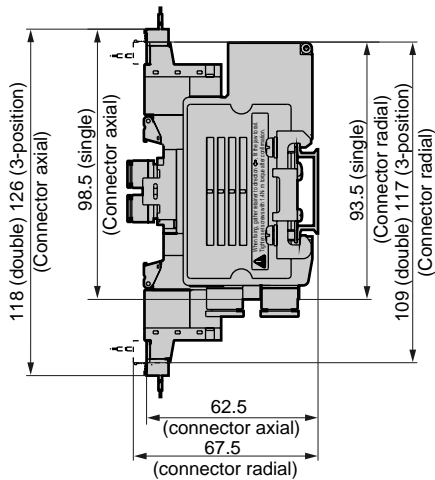
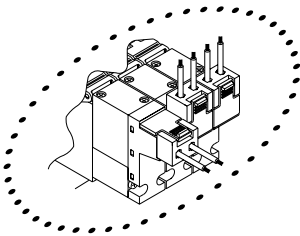

- EJ-connector type (E**J)

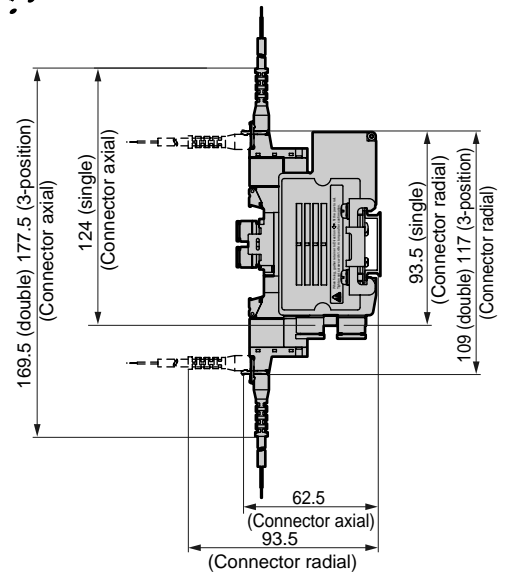
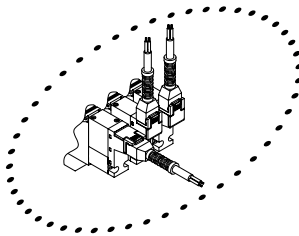

Note: Figure of E-connector (E), EJ-connector (E**J) shows dimensions of DC specifications.
 For AC specifications, valve overall length is single: 3.5mm longer, while double/3-position: 7mm longer.

4SA/B0

4SA/B1

4GA/B

MN4GA/B

4GA/B
 (master)

MN3S0/
 MN4S0

4TB

4L2-4/
 LMFO

4KA/B

4F

PV5/
 CMF

3MA/B0

3PA/B

P/M/B

NP/NAP/
 NVP

4F**0E

HMV/
 HSV

Uniwire
 system

SKH

PCD/
 FS/FD

3, 5 port pilot operated valve
 Individual wiring block manifold

Dimensions

• E-connector type (E)

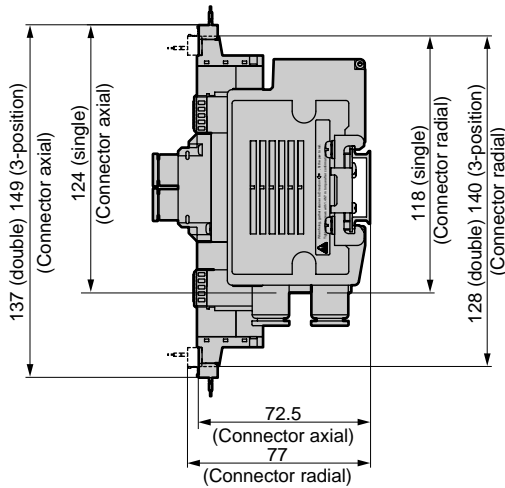
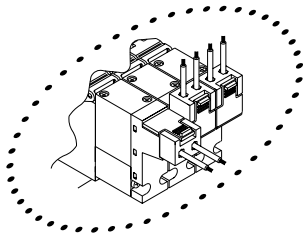

• EJ-connector type (E**J)

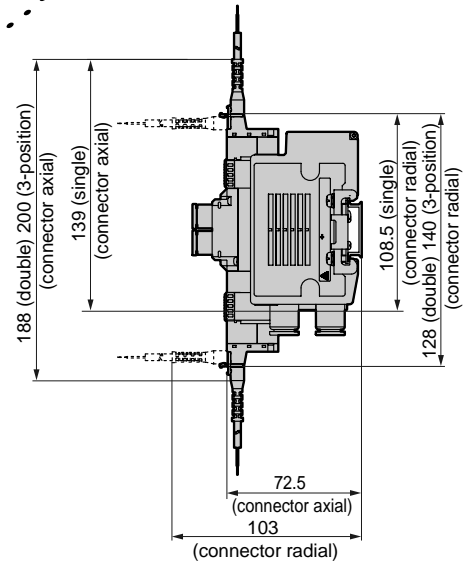
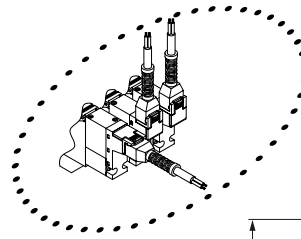

Note: Figure of E-connector (E), EJ-connector shows dimensions of DC specifications.
For AC specifications, valve overall length is single: 3.5mm longer, while double/3-position: 7mm longer.

• DIN terminal box type (B)

Reduced wiring not available.

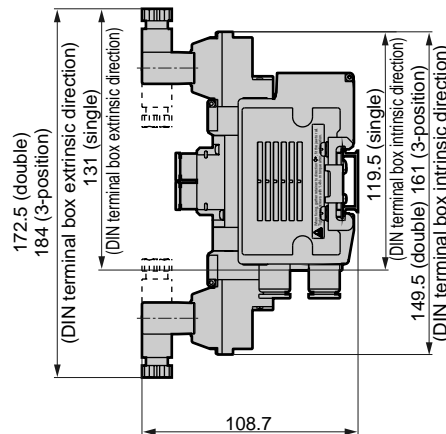
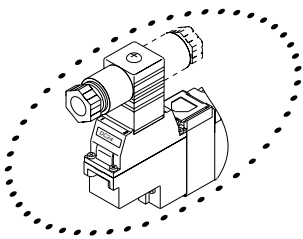

4SA/B0

4SA/B1

4GA/B

MN4GA/B

4GA/B (master)

MN3S0/ MN4S0

4TB

4L2-4/ LMFO

4KA/B

4F

PV5/ CMF

3MA/B0

3PA/B

P/M/B

NP/NAP/ NVP

4F**0E

HMV/ HSV

Uniwire system

SKH

PCD/ FS/FD

3, 5 port pilot operated valve
Individual wiring block manifold