





Standard cylinder——SE Series

In accordance with ISO15552 and VDMA24562 standard

Product series

Series name	Mounting type									Acting type	Bore size	Collocation of sensor switch	
	Basic	LB	FA	FB	CA	CB	CR	TC	FTC			CS1-E	DS1-E
Double acting type: SE 	●	●	●	●	●	●	●	●	●	Double acting	32 40 50 63 80 100 125	●	●
Double rod type: SED 	●	●	●	●	●	●	●	●	●			●	●
Adjustable stroke type: SEJ 	●	●	●	●	●	●	●	●	●			●	●
Page	176			178						457			

Installation and application

- When load changes in the work, the cylinder with abundant output capacity shall be selected.
- Relative cylinder with high temperature resistance or corrosion resistance shall be chosen under the condition of high temperature or corrosion.
- Necessary protection measure shall be taken in the environment with higher humidity, much dust or water drops, oil dust and welding dregs.
- Dirty substances in the pipe must be eliminated before cylinder is connected with pipeline to prevent the entrance of particles into the cylinder.
- The medium used by cylinder shall be filtered to 40 μm or below.
- Anti-freezing measure shall be adopted under low temperature environment to prevent moisture freezing.
- The cylinder shall be carried out test run without load before application. Prior to run, buffer shall be turned to the minimum and gradually released to avoid the damage on cylinder caused by excessive impact.
- The cylinder shall avoid the influence of side load in operation to maintain the normal work of cylinder and extend the service life.
- If the cylinder is dismantled and stored for a long time, please conduct anti-rust treatment to the surface. Anti-dust caps shall be added in air inlet and outlet ports.

Criteria for selection: Cylinder thrust

Unit: Newton(N)

Bore size (mm)	Rod size (mm)	Acting type	Pressure area (mm ²)	Operating pressure (MPa)									
				0.1	0.2	0.3	0.4	0.5	0.6	0.7	0.8	0.9	
32	12	Double acting	804	80.4	160.8	241.2	321.6	402.0	482.4	562.8	643.2	723.6	
		Push side	690	69.0	138.0	207.0	276.0	345.0	414.0	483.0	552.0	621.0	
40	16	Double acting	1256	125.6	251.2	376.8	502.4	628.0	753.6	879.2	1002.4	1130.4	
		Push side	1055	105.5	211.0	316.5	422.0	527.5	633.0	738.5	844.0	949.5	
50	20	Double acting	1963	196.3	392.6	588.9	785.2	981.5	1177.8	1374.1	1570.4	1766.7	
		Push side	1649	164.9	329.8	494.7	659.6	824.5	989.4	1154.3	1399.2	1484.1	
63	20	Double acting	3117	311.7	623.4	935.1	1246.8	1558.5	1870.2	2181.9	2493.6	2805.3	
		Push side	2803	280.3	560.6	840.9	1121.2	1401.5	1681.8	1962.1	2242.4	2522.7	
80	25	Double acting	5026	502.6	1005.2	1507.8	2010.4	2513.0	3015.6	3518.2	4020.8	4523.4	
		Push side	4536	453.6	907.2	1360.8	1814.4	2268.0	2721.6	3175.2	3628.8	4082.4	
100	25	Double acting	7853	785.3	1570.6	2355.9	3141.2	3926.5	4711.8	5497.1	6282.4	7067.7	
		Push side	7362	736.2	1472.4	2208.6	2948.6	3681.0	4417.2	5153.4	5889.6	6625.8	
125	32	Double acting	12272	1227.2	2454.4	3681.6	4908.8	6136.0	7363.2	8590.4	9817.6	11044.8	
		Push side	11468	1146.8	2293.6	3440.4	4587.2	5734.0	6880.8	8027.6	9174.4	10321.2	





Specification

Bore size(mm)	32	40	50	63	80	100	125
Acting type	Double acting						
Fluid	Air(to be filtered by 40 μ m filter element)						
Mounting type	SE	Basic FA FB CA CB CR LB TC FTC TCM1 TCM2					
	SED, SEJ	Basic FA LB TC FTC TCM1 TCM2					
Operating pressure	0.1~1.0MPa(15~145psi)(1.0~10.0bar)						
Proof pressure	1.5MPa(215psi)(15bar)						
Temperature °C	-20~80						
Speed range mm/s	30~800						30~500
Stroke tolerance	0~250 ^{+1.0} ₀		251~1000 ^{+1.5} ₀		1001~1500 ^{+2.0} ₀		
Cushion type	Variable cushion						
Adjustable cushion stroke mm	27		30		36		40
Port size ①	1/8"		1/4"		3/8"		1/2"

① PT thread, G thread and NPT thread are available.
Add) Refer to P457~480 for detail of sensor switch.

Stroke

Bore size (mm)	Standard stroke (mm)																Max. std stroke	Max. stroke					
32	25	50	75	80	100	125	150	160	175	200	250	300	350	400	450	500	1000	1800					
40	25	50	75	80	100	125	150	160	175	200	250	300	350	400	450	500	600	700	800	1200	1800		
50	25	50	75	80	100	125	150	160	175	200	250	300	350	400	450	500	600	700	800	900	1000	1200	1800
63	25	50	75	80	100	125	150	160	175	200	250	300	350	400	450	500	600	700	800	900	1000	1500	1800
80	25	50	75	80	100	125	150	160	175	200	250	300	350	400	450	500	600	700	800	900	1000	1500	1800
100	25	50	75	80	100	125	150	160	175	200	250	300	350	400	450	500	600	700	800	900	1000	1500	1800
125	25	50	75	80	100	125	150	160	175	200	250	300	350	400	450	500	600	700	800	900	1000	1500	1800

Note) Consult us for non-standard stroke.

Ordering code

SE	80	□	×	50	S	□	□	□
SED	80	□	×	50	S	□	□	□
SEJ	80	□	×	50-20	S	□	□	□

Model

- SE: Double acting type
- SED: Double rod type
- SEJ: Adjustable stroke type

Bore size

32 40 50 63 80 100 125

Rod Material

- Blank: Medium carbon steel
- A: SUS420J2
- B: SUS304
- C: SUS316

Stroke

Refer to stroke table for details

Adjustable stroke

- 10: 10mm
- 20: 20mm
- 30: 30mm
- 40: 40mm
- 50: 50mm
- 75: 75mm
- 100: 100mm

Magnet

- Blank: Without magnet
- S: With magnet

Thread type

- Blank: PT
- G: G
- T: NPT

Seals Material

- Blank: TPU
- H: Viton
- N: NBR

Mounting type ①

Mounting type	Available series	Memo
Blank	SE SED SEJ	
LB		
FA		
FB		
CA	SE	
CB		
CR		Be used with CB
FTC	SE SED SEJ	Be used with TCM1 TCM2
TC		

① Please refer to page 178~180 for accessory parts.

Symbol

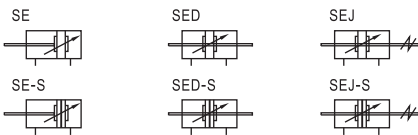

Product feature

1. ISO15552 and VDMA24562 standard cylinder;
2. The piston seal is composed of two Y-shape one-way seal structure, which has compensation function, long service life and low start-up pressure;
3. The square aluminum pipe without tie rod has good corrosion resistance;
4. The buffer adjustment of cylinder is smooth and steady;
5. Cylinders and accessories for installation with several specifications are optional.



ISO15552 Standard cylinder

SE Series

Inner structure and material of major parts

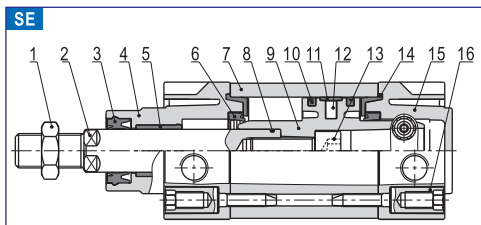

NO.	Item	Material
1	Rod nut	Carbon steel/Stainless steel
2	Piston rod	Carbon steel with 20 μ m chrome plated or Stainless steel
3	Front cover packing	TPU
4	Front cover	Aluminum alloy
5	Bushing	Wear resistant material
6	Cushing O-ring	TPU
7	Barrel	Aluminum alloy
8	O-ring	NBR
9	Piston	Aluminum alloy
10	Piston Seal	TPU
11	Wear ring	Wear resistant material
12	Magnet	Plastic/Rubber(Φ 125)
13	Bolt	Carbon steel
14	Buffer gasket	TPU
15	Back cover	Aluminum alloy
16	Screw	Carbon steel/Stainless steel

Dimensions

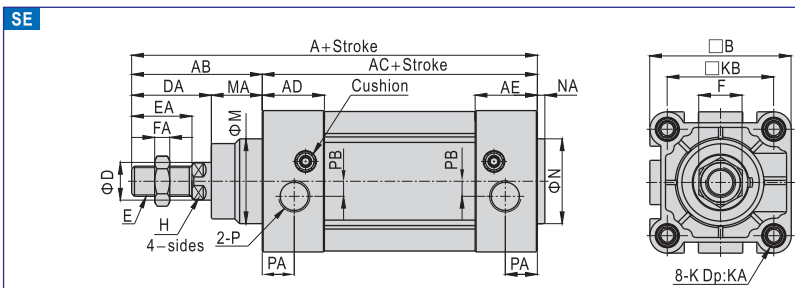

Bore size\Item	A	AB	AC	AD	AE	B	D	DA	E	EA
32	142	48	94	27.5	27.5	46.5	12	29	M10×1.25	22
40	159	54	105	32	32	54	16	33	M12×1.25	24
50	175	69	106	31	31	64	20	42	M16×1.5	32
63	190	69	121	33	33	75	20	42	M16×1.5	32
80	214	86	128	33	33	93	25	53	M20×1.5	40
100	229	91	138	37	37	110	25	55	M20×1.5	40
125	279	119	160	46	46	134	32	74	M27×2.0	54

Bore size\Item	F	FA	H	K	KA	KB	M	MA	N	NA	P	PA	PB
32	17	6	10	M6	16	32.5	30	19	30	3	1/8"	13.5	6
40	17	7	13	M6	16	38	35	21	35	3.5	1/4"	17.5	6
50	23	8	17	M8	16	46.5	40	27	40	3.5	1/4"	14	8
63	23	8	17	M8	16	56.5	45	27	45	4	3/8"	17	8
80	26	10	22	M10	17	72	45	33	45	4	3/8"	16.5	8
100	26	10	22	M10	17	89	55	36	55	4	1/2"	19.5	10
125	41	13.5	27	M12	20	110	60	45	60	4	1/2"	23	11

Remark: The dimensions of magnet type cylinder are the same as non-magnet type cylinder.

SED

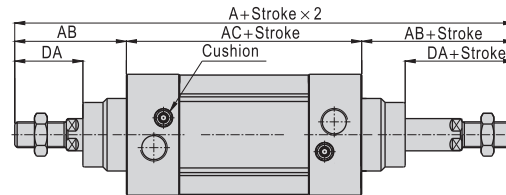

SEJ

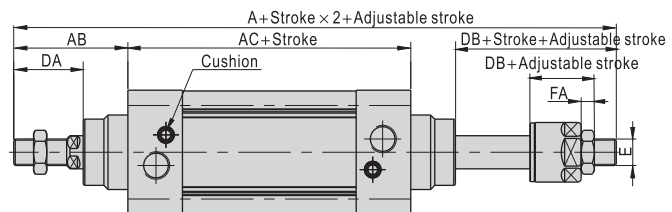

Bore size\Item	A		AB	AC	DA	DB	E	FA
	SED	SEJ						
32	190	188	48	94	29	27	M10X1.25	6
40	213	208	54	105	33	28	M12X1.25	7
50	244	231	69	106	42	29	M16X1.5	8
63	259	246	69	121	42	29	M16X1.5	8
80	300	282.5	86	128	53	35.5	M20X1.5	10
100	320	300.5	91	138	55	35.5	M20X1.5	10
125	398	366.5	119	160	74	42.5	M27X2.0	13.5

Remark:

1. The dimensions of magnet type cylinder are the same as non-magnet type cylinder.
2. The unmarked dimension is the same as SE standard type.

Accessories

Ordering code

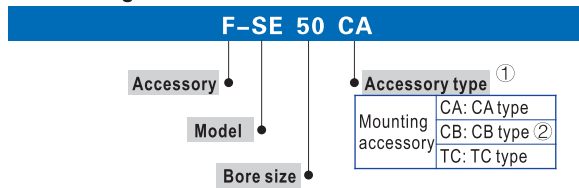

- ① The listed accessories are for SE cylinder. Accessories that are adaptable to other cylinders are not shown. Please refer to accessory list on P180 for selection and ordering information.
 ② CB is attached with relevant PIN.

Accessory selection

Cylinder model	SE	SED	SEJ	
	Standard With magnet	Standard With magnet	Standard With magnet	
Accessories				
Mounting accessory	LB	●	●	●
	FA	●	●	●
	FB	●	×	×
	CA	●	×	×
	CB	●	×	×
	CR	●	×	×
	TC	●	●	●
	FTC	●	●	●
	TCM1	●	●	●
	TCM2	●	●	●
Knuckle ①	I	●	●	●
	Y	●	●	●
	U	●	●	●
	F	●	●	●
Sensor switch ②	CS1-E	×	●	×
	CS1-EX	×	×	×
	DS1-E	×	×	×
	DS1-EN	×	×	×
	DS1-EP	×	×	×

- ① Please refer to P453-456 for knuckle detail,
 ② Please refer to P457-480 for detail of sensor switch.

Material of accessories

Accessories	Mounting accessories							Knuckle					
	LB	FA	FB	CA	CB	CR	FTC	TCM1	TCM2	I	Y	F	U
Bore size 32-100	○	●	●	◇	◇	◇	■	■	●	□	□	□	□
125	■	■	■	■	■	■	■	■	■	□	□	□	□

- Aluminum alloy, ▲ S45C, ■ Cast steel,
 ○ Low carbon steel, ◇ Nodular cast iron, □ Carbon steel.

Dimensions

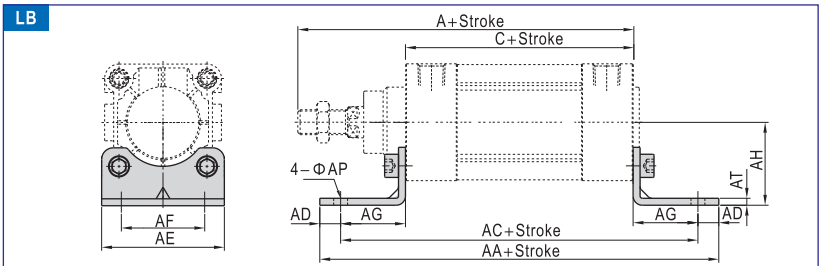

Bore size\Item	A	C	AA	AC	AD	AE	AF	AG	AH	AP	AT
32	142	94	158	142	8	47	32	24	32	7	3
40	159	105	179	161	9	53	36	28	36	9	3
50	175	106	190	170	10	65	45	32	45	9	3
63	190	121	209	185	12	75	50	32	50	9	3
80	214	128	248	210	19	95	63	41	63	12.5	4
100	229	138	266	228	19	115	75	45	71	14.5	4
125	279	160	290	250	20	140	90	45	90	16.5	8

FA/FB

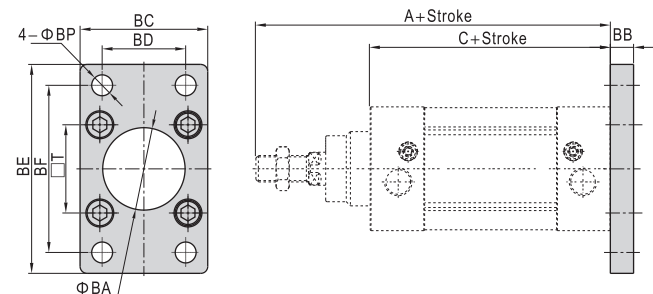
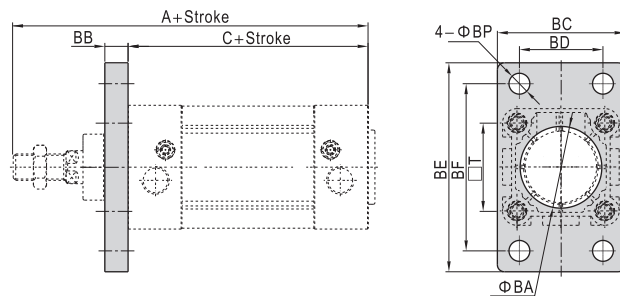

Bore size\Item	A	C	BA	BB	BC	BD	BE	BF	BP	T
32	142	94	30.5	10	47	32	80	64	7	32.5
40	159	105	35.5	10	53	36	90	72	9	38
50	175	106	40.5	12	65	45	108	90	9	46.5
63	190	121	45.5	12	75	50	118	100	9	56.5
80	214	128	45.5	16	95	63	150	126	12.5	72
100	229	138	55.5	16	115	75	176	150	14.5	89
125	279	160	60.5	20	139	90	218	180	16.5	110

CA

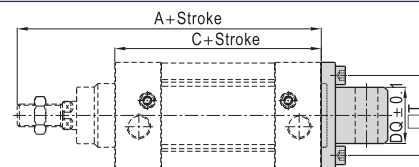

Bore size\Item	A	C	S	T	DC	DD	DE	DJ	DQ
32	142	94	46.5	32.5	22	10.5	10	13	25.8
40	159	105	54	38	25	12	12	16	27.8
50	175	106	64	46.5	27	12	12	17	31.7
63	190	121	75	56.5	32	15	16	22	39.7
80	214	128	93	72	36	15.5	16	22	49.7
100	229	138	110	89	41	20	20	27	59.7
125	279	160	134	110	50	24	25	33	69.7

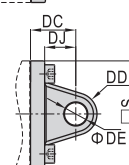

Accessories

CB

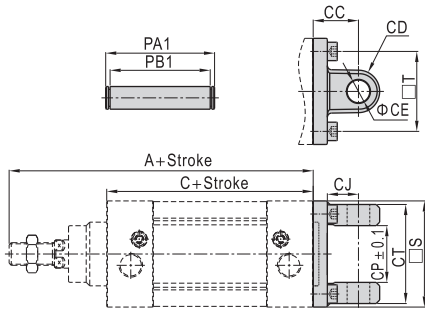

Bore size\Item	A	C	CC	CD	CE	CJ	CP	CT	PA1	PB1	S	T
32	142	94	22	10.5	10	13	26	45	51	45.5	46.5	32.5
40	159	105	25	12	12	16	28	52	59	52.5	54	38
50	175	106	27	12	12	17	32	60	67	60.5	64	46.5
63	190	121	32	15	16	22	40	70	77	70.5	75	56.5
80	214	128	36	15.5	16	22	50	90	97	90.5	93	72
100	229	138	41	20	20	27	60	110	119	110.5	110	89
125	279	160	50	24	25	33	70	130	139	130.5	134	110

CR

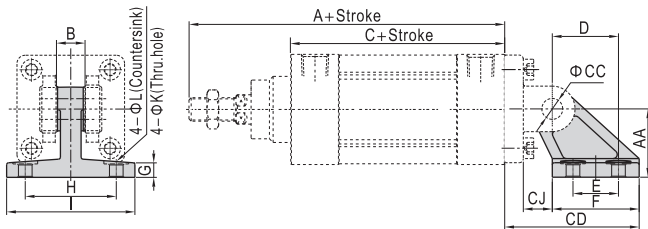

Bore size\Item	A	AA	B	C	CC	CD	CJ	D	E	F	G	H	I	K	L
32	142	32	26	94	10	50	10	21	18	31	8	38	51	6.6	-
40	159	36	28	105	12	56	12	24	22	35	10	41	54	6.6	-
50	175	45	32	106	12	68	13	33	30	45	12	50	65	9	-
63	190	50	40	121	16	77	17	37	35	50	12	52	67	9	-
80	214	63	50	128	16	93	19	47	40	60	14	66	86	11	18
100	229	71	60	138	20	106	22	55	50	70	15	76	96	11	18
125	279	90	70	160	25	135	26	70	60	90	20	94	124	14	20

Note) CR can't be used alone, it must be used with CB.

FTC

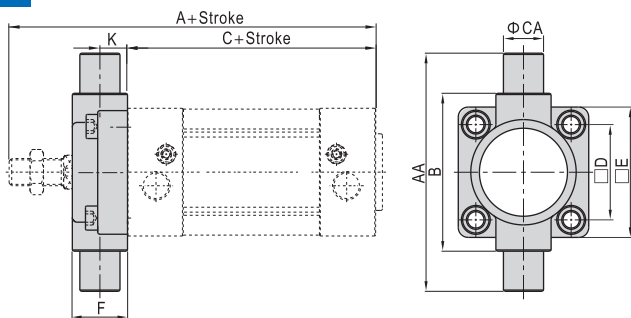

Bore size\Item	A	C	AA	B	CA	D	E	F	K
32	142	94	74	50	12	32.5	46	19	10
40	159	105	95	63	16	38	52	21	10
50	175	106	107	75	16	46.5	64	26	12
63	190	121	130	90	20	56.5	74	28	12
80	214	128	150	110	20	72	94	31	16
100	229	138	182	132	25	89	114	35	16
125	279	160	210	160	25	110	139	43	20

TCM1

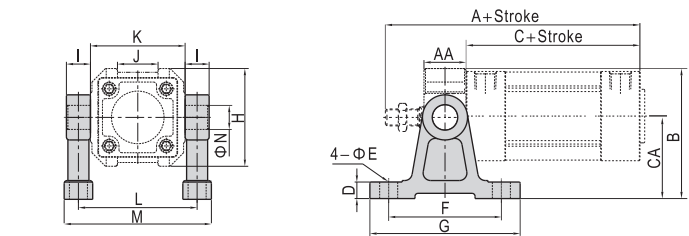

Bore size\Item	A	C	AA	B	CA	D	E	F	G	H	I	J	K	L	M	N
32	142	94	19	66	40	11	9	60	80	52	12	20	50	62	77	12
40	159	105	21	86.5	54	11	12	75	100	65	16	27	63	79	98	16
50	175	106	26	91.5	54	11	12	75	100	75	16	31	75	91	110	16
63	190	121	28	115	70	11	12	85	110	90	20	42	90	110	133	20
80	214	128	31	126	70	11	12	85	110	112	20	54	110	130	153	20
100	229	138	35	157.5	90	19	18	115	155	135	25	68	135	157	185	25
125	279	160	43	169.3	90	19	18	115	155	170	25	80	160	185	213	25

Note) The installation position of the accessories can not be adjusted arbitrarily.

TCM2

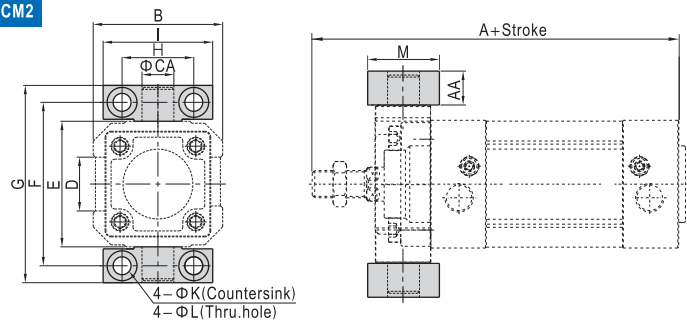

Bore size\Item	A	AA	B	CA	D	E	F	G	H	I	K	L	M
32	142	14	52	12	20	50	66	80	32	46	11	7	30
40	159	17	65	16	27	63	82	99	36	55	15	9	36
50	175	17	75	16	31	75	94	111	36	55	15	9	36
63	190	20.5	90	20	42	90	113.5	134	42	65	18	11	40
80	214	20.5	112	20	54	110	133.5	154	42	65	18	11	40
100	229	24.5	135	25	68	132	159.5	184	50	75	20	14	50
125	279	24.5	170	25	80	160	187.5	212	50	75	20	14	50

Note) The installation position of the accessories can not be adjusted arbitrarily.

TC

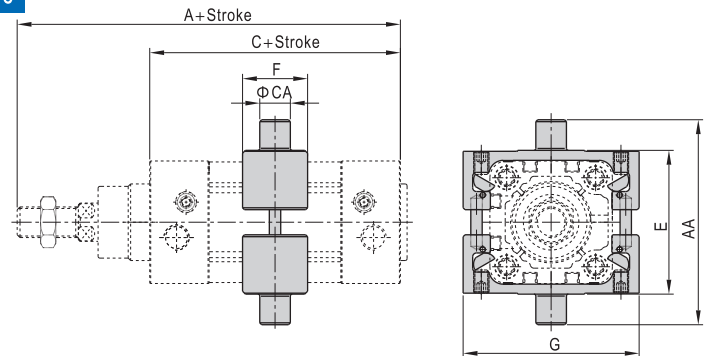

Bore size\Item	A	AA	C	CA	E	F	G
32	142	74	94	12	52	31	68
40	159	95	105	16	63	33	78
50	175	107	106	16	75	35	95
63	190	130	121	20	90	37	108
80	214	150	128	20	110	41	130
100	229	182	138	25	132	47	148
125	279	210	160	25	160	51	173

Accessories

List for ordering code of accessories

Accessories Bore size	Mounting accessory			
	LB	FA	FB	CA
32	F-SI32LB	F-SI32FA		F-SE32CA
40	F-SI40LB	F-SI40FA		F-SE40CA
50	F-SI50LB	F-SI50FA		F-SE50CA
63	F-SI63LB	F-SI63FA		F-SE63CA
80	F-SI80LB	F-SI80FA		F-SE80CA
100	F-SI100LB	F-SI100FA		F-SE100CA
125	F-SI125LB	F-SI125FA		F-SE125CA

Accessories Bore size	Mounting accessory		
	CB	CR	TC ①
32	F-SE32CB	F-SI32CR	F-SE32TC
40	F-SE40CB	F-SI40CR	F-SE40TC
50	F-SE50CB	F-SI50CR	F-SE50TC
63	F-SE63CB	F-SI63CR	F-SE63TC
80	F-SE80CB	F-SI80CR	F-SE80TC
100	F-SE100CB	F-SI100CR	F-SE100TC
125	F-SE125CB	F-SI125CR	F-SE125TC

Accessories Bore size	Mounting accessory		
	FTC	TCM1	TCM2
32	F-SI32FTC	F-SI32TCM1	F-SI32TCM2
40	F-SI40FTC	F-SI40TCM1	F-SI40TCM2
50	F-SI50FTC	F-SI40TCM1	F-SI40TCM2
63	F-SI63FTC	F-SI63TCM1	F-SI63TCM2
80	F-SI80FTC	F-SI63TCM1	F-SI63TCM2
100	F-SI100FTC	F-SI125TCM1	F-SI125TCM2
125	F-SI125FTC	F-SI125TCM1	F-SI125TCM2

Accessories Bore size	Knuckle			
	I: I Knuckle	Y: Y Knuckle	F: F Knuckle	U: U Knuckle
32	F-M10X125I	F-M10X125Y	F-M10X125F	F-M10X125U
40	F-M12X125I	F-M12X125Y	F-M12X125F	F-M12X125U
50	F-M16X150I	F-M16X150Y	F-M16X150F	F-M16X150U
63	F-M16X150I	F-M16X150Y	F-M16X150F	F-M16X150U
80	F-M20X150I	F-M20X150Y	F-M20X150F	F-M20X150U
100	F-M20X150I	F-M20X150Y	F-M20X150F	F-M20X150U
125	F-M27X200I	F-M27X200Y	-	F-M27X200U

Accessories Bore size	Sensor switch				
	CS1-E	CS1-EX	DS1-E	DS1-EN	DS1-EP
32-125	CS1-E	CS1-EX	DS1-E	DS1-EN	DS1-EP

How to mount TC bracket

The process of mounting

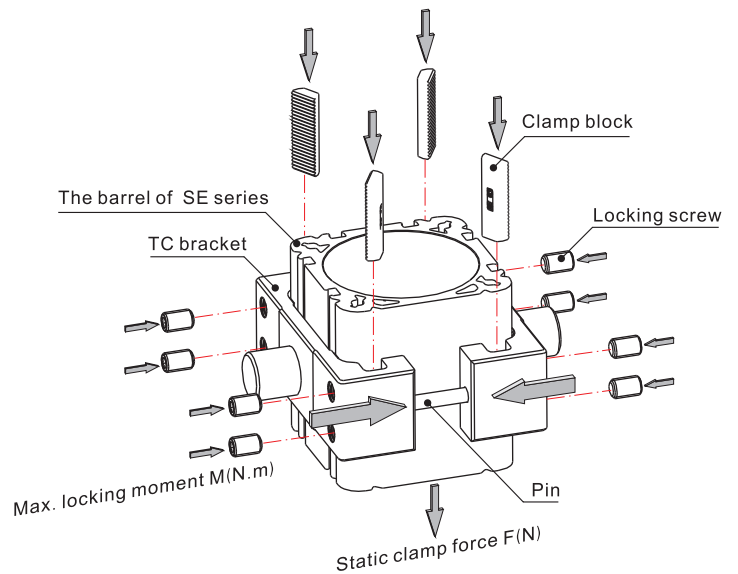

The accomplished of mounting

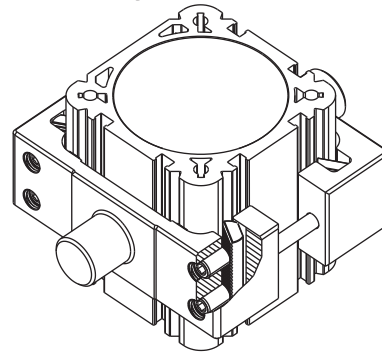

Please install TC bracket by below steps:

- ① Hitched half of TC bracket over the barrel, and adjust it to the adapted position.
- ② Insert the both sides pin of the TC bracket.
- ③ Aimed another half of TC bracket's pin hole at pin and hitched another half of TC bracket over the barrel.
- ④ Posting clamp block in the four nook of TC bracket by upper picture.
- ⑤ Screw down eight locked screws from side face of TC bracket, and lock TC bracket with the max. locking moment of below table. the static clamp force(F) as below table:

Bore size	Max. locking moment M(N.m)	Static clamp force F(N)
32	3	800
40	6	1200
50	6	2000
63	12	3000
80	20	5000
100	20	8000
125	30	12000